

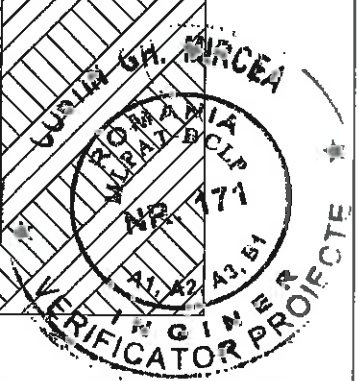
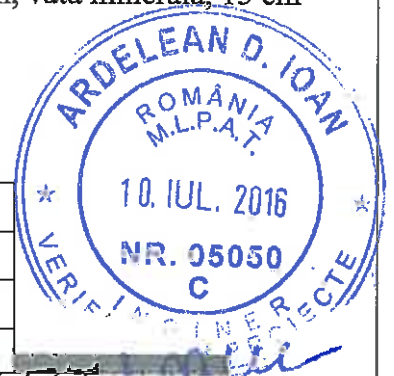
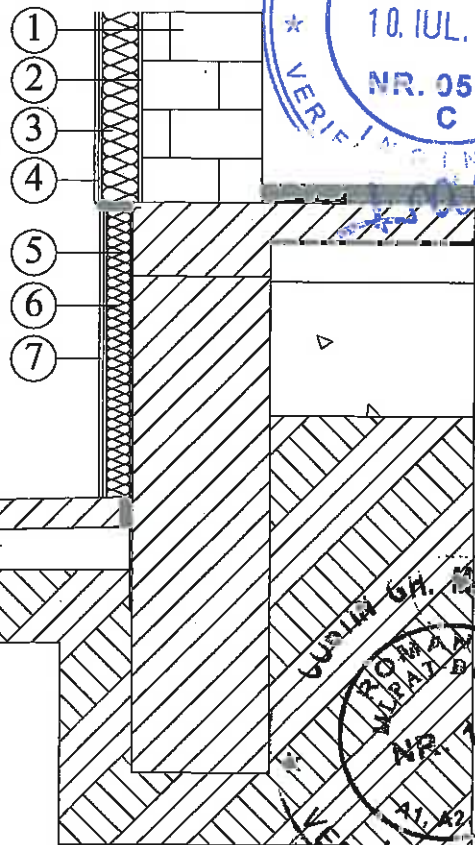

DETALIU RACORDARE LA ACOPERIS INCLINAT

1. Finisaj
2. Termoizolatie, polistiren de fatada ignifugat 10 cm
3. Pazie
4. Sistem de invelitoare
5. Termoizolatie intre rigle de lemn, vata minerala, 15 cm

DETALIU SOCLU IZOLAT

1. Perete exterior
2. Adeziv pentru izolatia termica
3. Termoizolatie, polistiren de fatada ignifugat 10 cm
4. Finisaj
5. Hidroizolatie
6. Polistiren extrudat, 3 cm
7. Tencuiala de soclu



Verificator					
Expert					
Verificator/ Expert	Nume	Semnatura	Cerinta	REFERAT de verificare/RAPORT de experza tehnica	
 CENTRUL DE PROIECTARE SI INGINERIE S.R.L. Satu Mare, str. Corneliu Coposcu 2/57A, nr. ORC J304402309, CUI RO25628988 tel/fax 0744.513524/0361.86017, e-mail: office@cpism.ro			Beneficiar:		Proiect nr.
			COMUNA GILGAU, JUDETUL SALAJ		56/C30/PTH/2016
Specificae	Nume	Semnatura	scara	Titlu proiect:	
Sef Proiect	arh. NEGRU OVIDIU		1:20	MODERNIZARE CAMIN CULTURAL	
Proiectat	arh. NEGRU OVIDIU		data	IN SATUL DOBROCINA, COMUNA GILGAU	
Desenat	arh. st. STAN ANCA OANA		mai 2016	Titlu plansa:	DETALII TERMOIZOLARE
					Faza P.TH.+ D.D.E.
					Plansa nr. D01

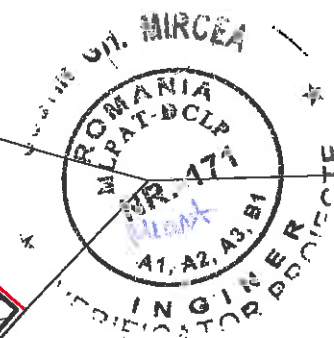
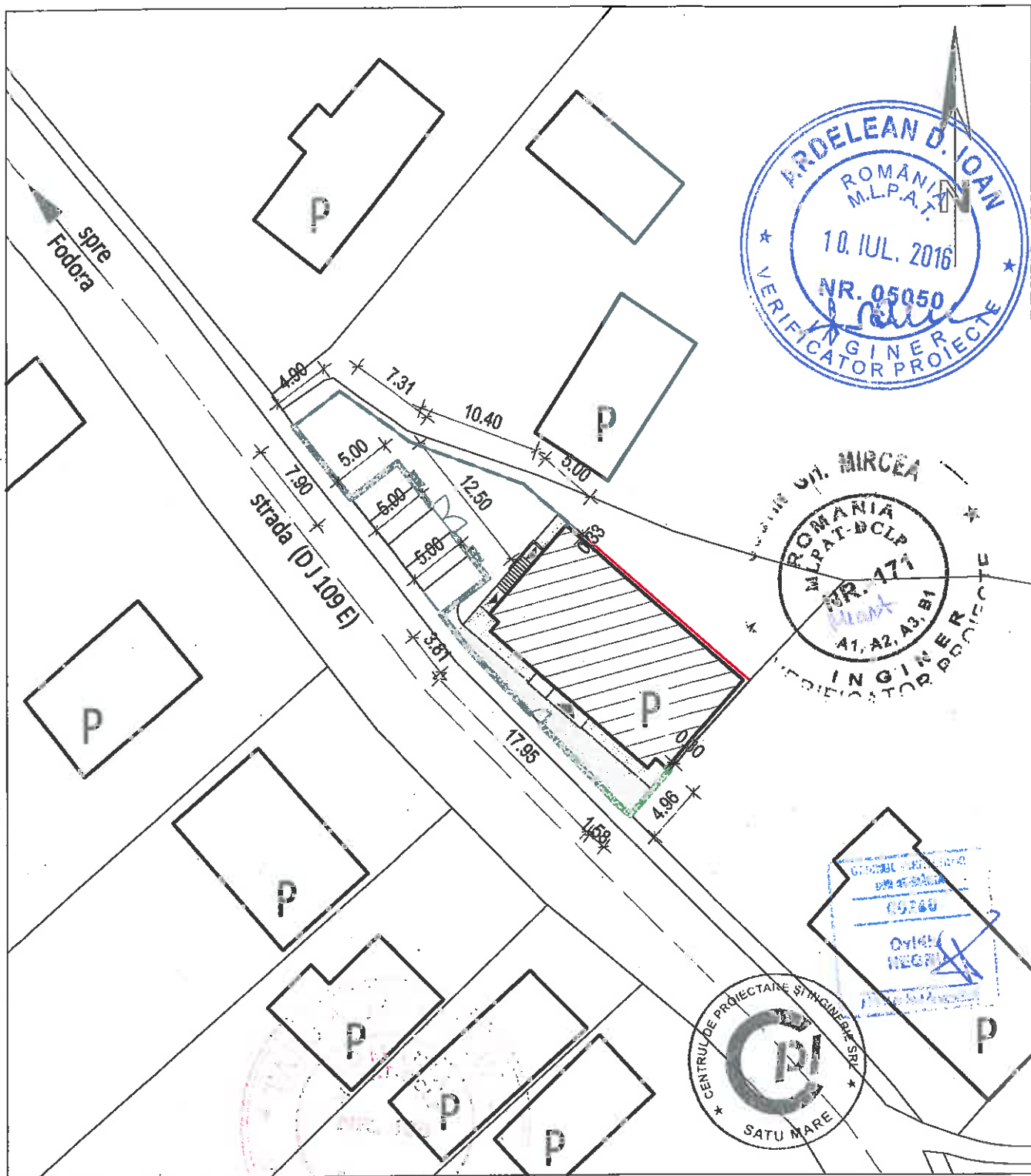

- LIMITA PRORIETATE
- CLADIRI EXISTENTE
- CLADIRE STUDIATA
- ACCESE CLADIRE
- CIRCULATII INCINTA
- CURTE AMENAJATA
- PLATFORME AMPLASARE BANCI
- IMPREJMUIRE TIP 1
- IMPREJMUIRE TIP 2

Verificator				
Expert				
Verificator/ Expert	Nume	Semnatura	Cerinta	REFERAT de verificare/RAPORT de expertiza tehnica
	CENTRUL DE PROIECTARE SI INGINERIE S.R.L. SATU MARE, str. Corneliu Coposu 2/57A, nr. ORC I30/440/2009, CUI RO25628958 tel/fax 0744.513.524/0361.884.017, e-mail: office@cpism.ro		Beneficiar:	COMUNA GILGAU, JUDETUL SALAJ Proiect nr. 56/C30/PTH/2016
Specificatie	Nume	Semnatura	SCARA	Titlu proiect: MODERNIZARE CAMIN CULTURAL IN SATUL DOBROCINA, COMUNA GILGAU Faza P.TH.+ D.D.E.
Sef Proiect	arh. NEGRU OVIDIU		1:500	
Proiectat	arh. NEGRU OVIDIU		data	Titlu plansa: IMPREJMUIRE. PLAN DE SITUATIE Plansa nr. AI. 01
Desenat	ing. AGRIGOROAEI SORIN		mai 2016	

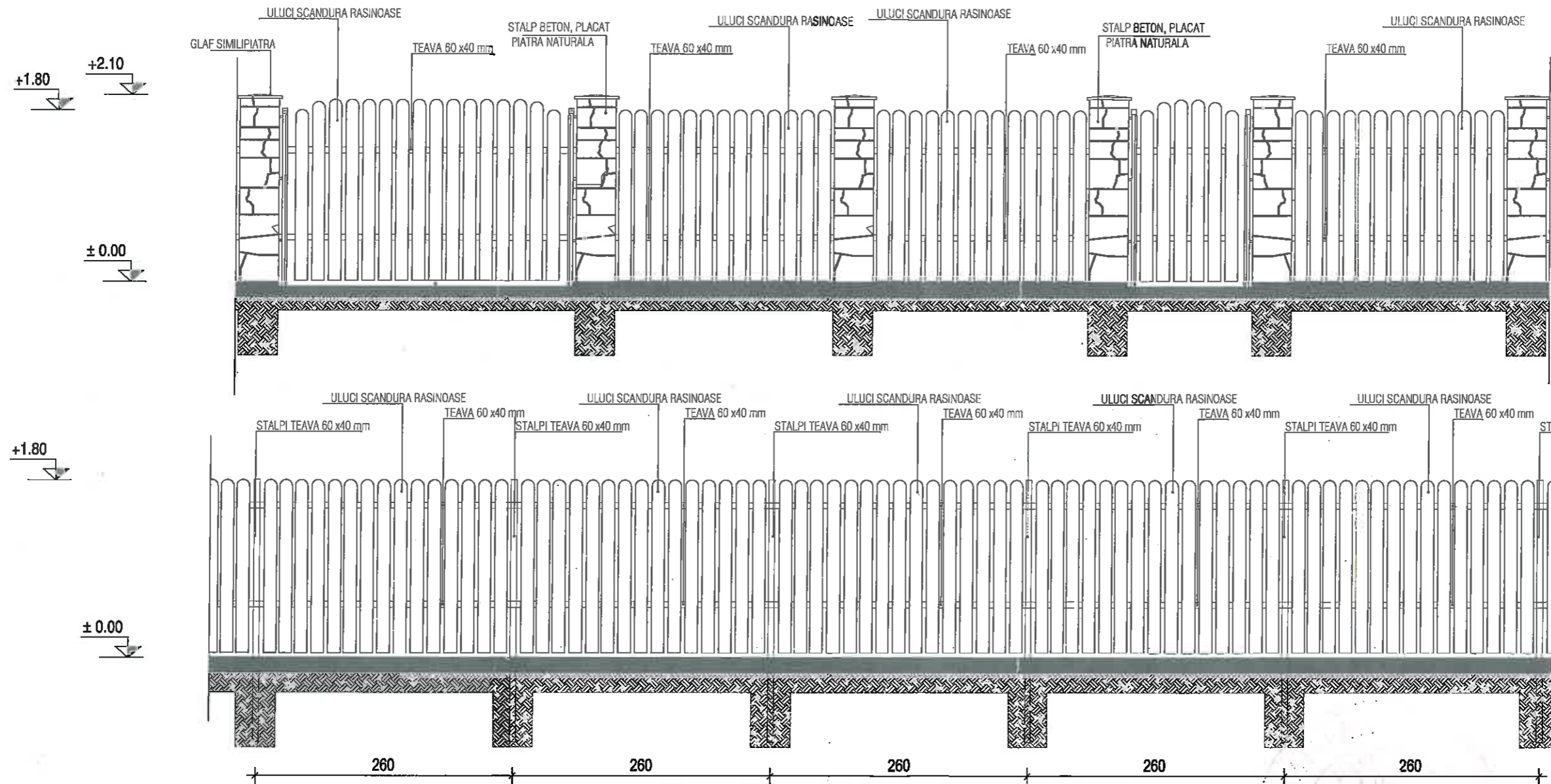

Verificator				
Expert				
Verificator/ Expert	Nume	Semnatura	Cerinta	REFERAT de verificare/RAPORT de expertiza tehnica
CENTRUL DE PROIECTARE SI INGINERIE S.R.L. SATU MARE, str. Corneliu Coposu 2/57A, nr. ORC J30/440/2009, CUI RO25628958 tel/fax 0744.513.524/0361.884.017, e-mail: office@cpism.ro	Beneficiar:		COMUNA GILGAU, JUDETUL SALAJ	
	Proiect nr. 56/C30/PTH/2016			
Specificatie	Nume	Semnatura	SCARA	Titlu proiect:
Sef Proiect	arh. NEGRU OVIDIU		1:50	MODERNIZARE CAMIN CULTURAL IN SATUL DOBROCINA, COMUNA GILGAU
Proiectat	arh. NEGRU OVIDIU		data	Titlu plansa:
Desenat	ing. MAIER LUCICA		mai 2016	TIPURI IMPREMIURE
				Faza P.TH.+ D.D.E.
				Plansa nr. D1.02

DETALII STRUCTURA GARD CU PANOURI DE LEMN SI CU STALPI METALICI (28.0 ML)

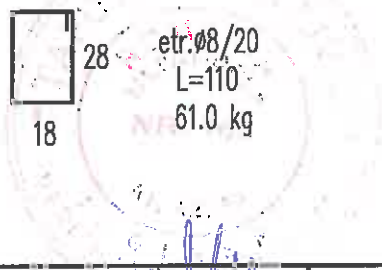
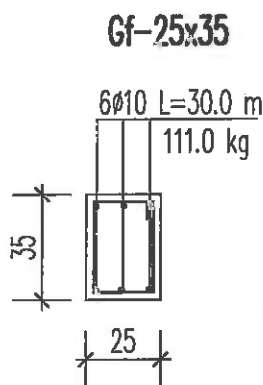
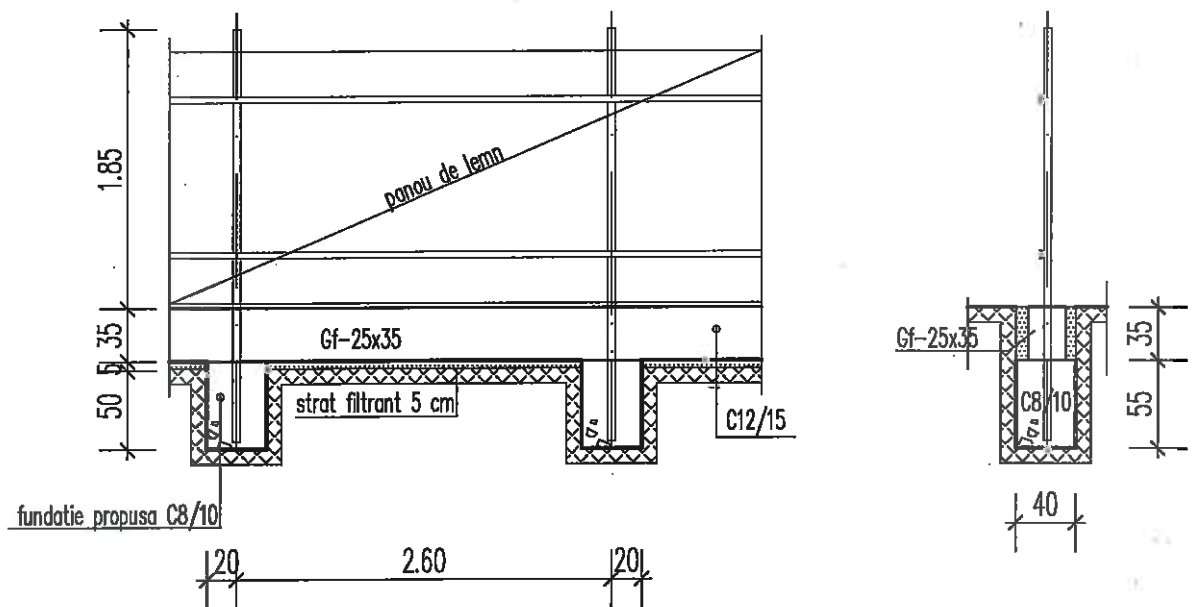

Verificator					
Expert					
Verificator/ Expert	Nume	Semnatura	REFERAT de verificare/RAPORT de expertiza tehnica		
	CENTRUL DE PROIECTARE SI INGINERIE S.R.L. Satu Mare, str. Corneliu Coposu 2/57A, nr. ORC J30/440/2008, CUI RO28628951 tel/fax 0744.513524/0361.884.017, e-mail: office@cpism.ro		Beneficiar:	COMUNA GILGAU, JUDETUL SALAJ Proiect nr. 56/C30/PTH/2016	
	Specificatie	Nume	Semnatura	SCARA	Titlu proiect:
Sef Proiect	arh. NEGRU OVIDIU		1:50,25	MODERNIZARE CAMIN CULTURAL IN SATUL DOBROCINA, COMUNA GILGAU	Faza P.TH. D.D.E
Proiectat	ing. SARGA GABRIELLA		data	Titlu plansa:	Plansa nr.
Desenat	ing. SARGA GABRIELLA		mai 2016	DETALII STRUCTURA GARD CU STALI METALICI	Ri 01

DETALII STRUCTURA GARD CU PANOURI DE LEMN SI CU STALPI DE BETON PLACATI CU PIATRA (55.0 ML.)

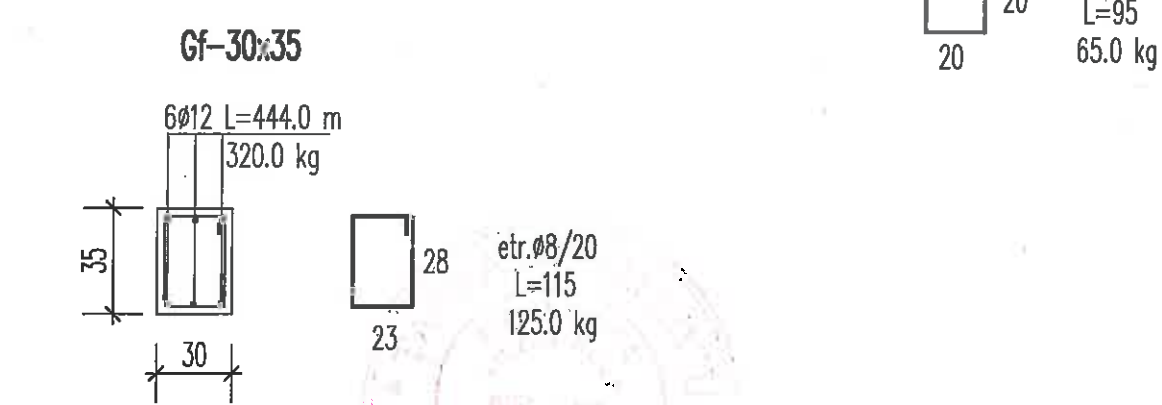
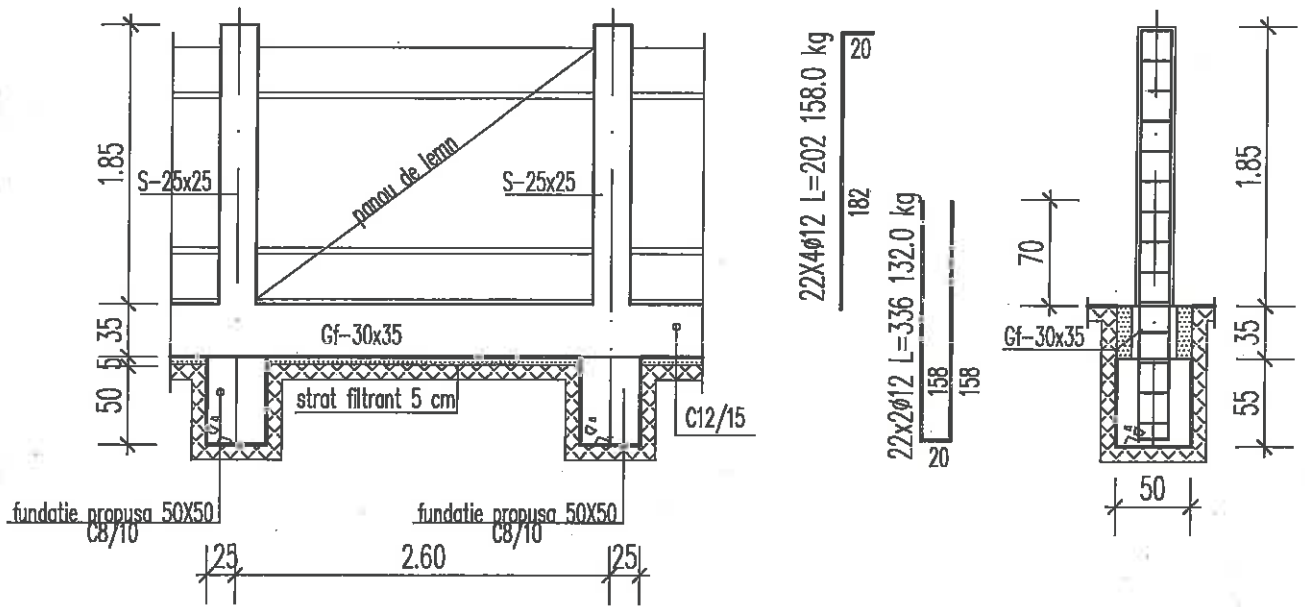

Verificator			
Expert			
Verificator/ Expert	Nume	Semnatura	Beneficiar: CEFERAT de verificare/RAPORT de expertiza tehnica
	CENTRUL DE PROIECTARE SI INGINERIE S.R.L. Satu Mare, str. Corneliu Coposu 2/57A, nr. ORC J30/440/2009, CUI RO28628958 tel/fax 0744.513524/0361.884.017, e-mail: office@cpism.ro		Beneficiar: COMUNA GILGAU, JUDETUL SALAJ
			Proiect nr. 56/C30/PTH/2016
Specificatie	Nume	Semnatura	SCARA 1:50,25
Sef Proiect	arh. NEGRU OVIDIU		Titlu proiect: MODERNIZARE CAMIN CULTURAL IN SATUL DOBROCINA, COMUNA GILGAU
Proiectat	ing. SARGA GABRIELLA		Titlu plansa: DETALII STRUCTURA GARD CU STALPI DE BETON
Desenat	ing. SARGA GABRIELLA		Faza P.TH. D.D.E Plansa nr. Ri 02



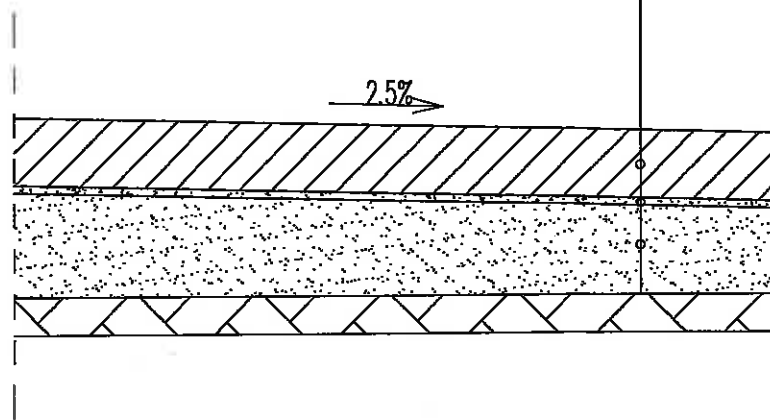

PROFIL TRANSVERSAL – PLATFORMA PARCAJ, SUB BANCII

STRAT DE REZISTENTA SI UZURA BETON C22.5-18 CM GROSIME
 NISIP SPALAT- 2 CM GROSIME
 FUNDATIE DIN BALAST- 20 CM GROSIME

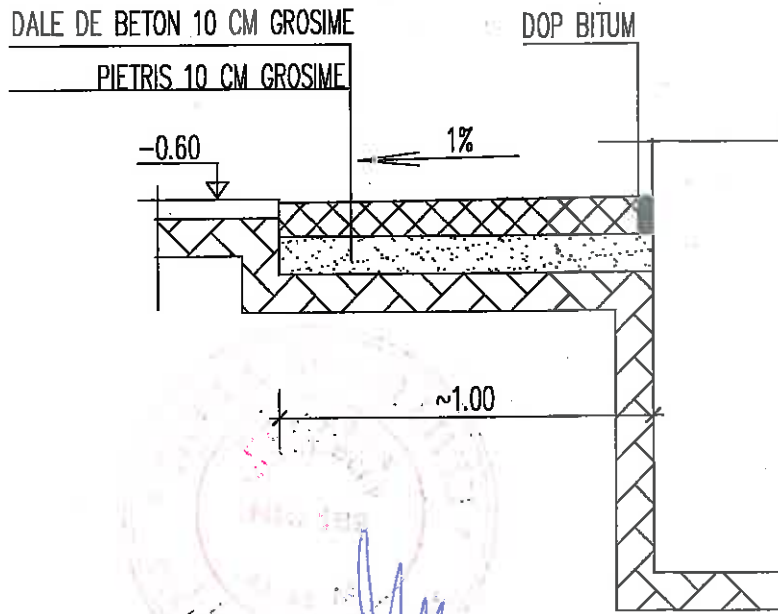

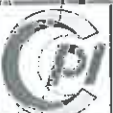
PROFIL TRANSVERSAL --CIRCULATIE PIETONALA

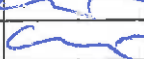

Verificator					
Expert					
Verificator/ Expert	Nume	Semnatura		REFERAT de verificare/RAPORT de expertiza tehnica	
	CENTRUL DE PROIECTARE SI INGINERIE S.R.L. Satu Mare, str. Corneliu Coposu 2/57A, nr. ORC J30/440/2009, CUI RO25628958 tel/fax 0744.513524/0361.884.017, e-mail: office@cpism.ro		Beneficiar	COMUNA GILGAU, JUDETUL SALAJ	Proiect nr. 56/C30/PTH/2016
Specificatie	Nume	Semnatura	SCARA	Titlu proiect:	Faza
Sef Proiect	arh. NEGRU OVIDIU		1:20	MODERNIZARE CAMIN CULTURAL IN SATUL DOBROCINA, COMUNA GILGAU	P.T.H. D.D.E
Proiectat	ing. SARGA GABRIELLA		data		Planşa nr.
Desenat	ing. SARGA GABRIELLA		mai 2016	Titlu planşa: SECTIUNI CIRCULATIA AUTO SI PIETONALA	D01

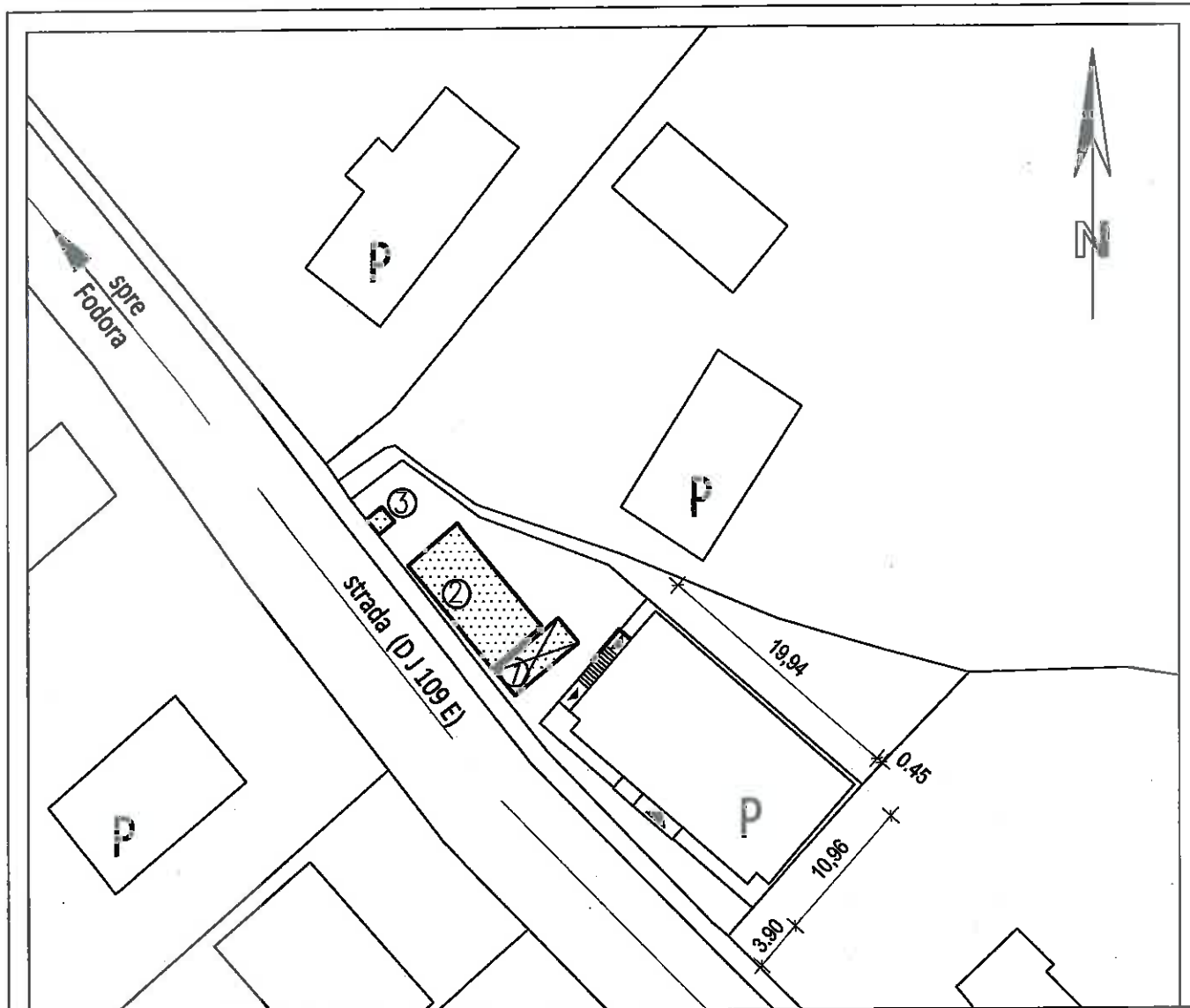

LEGENDA:

- ① BARACA (DEPOZIT SCULE SI UNELTE, PRISPA)
- ② PLATFORMA-DEPOZIT MATERIALE
- ③ CABINA WC ECOLOGICA

Verificator					
Expert					
Verificator/ Expert	Nume	Semnatura	Cerinta	REFERAT de verificare/RAPORT de expertiza tehnica	
	CENTRUL DE PROIECTARE SI INGINERIE S.R.L. SATU MARE, str. Corneliu Coposu 2/57A, nr. ORC J30/440/2009, CUI RO25628958 tel/fax 0744.513.524/0361.884.017, e-mail: office@cplsm.ro		Beneficiar:		Proiect nr.
				COMUNA GILGAU, JUDETUL SALAJ	
					56/C30/PTH/2016
Specificatie	Nume	Semnatura	SCARA	Titlu proiect:	
Sef Proiect	arh. NEGRU OVIDIU		1:500	MODERNIZARE CAMIN CULTURAL IN SATUL DOBROCINA, COMUNA GILGAU	
Proiectat	arh. NEGRU OVIDIU		data	Faza	
Desenat	ing. AGRIGOROEI SORIN		MAI. 2016	PTH+DDE	
				Titlu plansa: PLAN DE SITUATIE- ORGANIZARE DE SANTIER	
				Plansa nr. OS. 01	

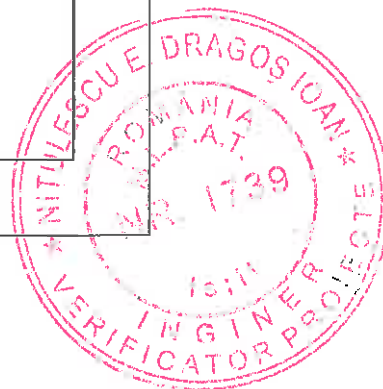
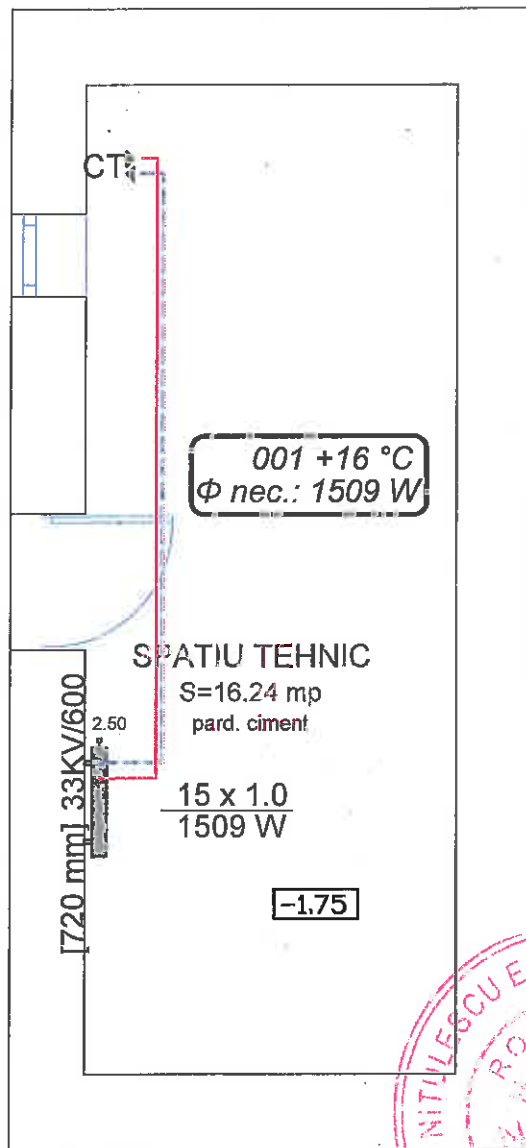

LEGENDA

- tur incalzire in tub de protectie
- - - retur incalzire in tub de protectie
- radiator tabla de otel echipat cu cap termostatat si ventil de aerisire si de inchidere

Verificator						
Expert					1027/15.06.2016	
Verificator/ Expert	Nume	Semnatura	Cerinta	REFERAT de verificare/RAPORT de expertiza tehnica		
	CENTRUL DE PROIECTARE SI INGINERIE S.R.L. SATU MARE, str. Corneliu Coposu 2/57A, nr. ORC J30/440/2009, CUI RO25628958 tel/fax 0744.513.524/0361.884.017, e-mail: office@cpism.ro		Beneficiar:		Proiect nr.	
				COMUNA GILGAU, JUDETUL SALAJ		56/C30/ PTH/2016
Specificatie	Nume	Semnatura	SCARA	Titlu proiect:		
Proiectat	ing. MANESSES SANDOR		1:50	MODERNIZARE CAMIN CULTURAL IN SATUL DOBROCINA, COMUNA GILGAU		
Desenat	ing. VARGA ERIKA		data	Titlu plansa:		
Sef Proiect	arh. NEGRU OVIDIU		MAI 2016	Instalatii Termice PLAN DEMISOL		
					Faza P.TH.+ D.D.E.	
					Plansa nr. IT 01	

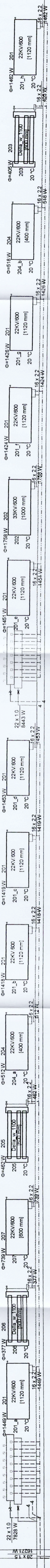

LEGENDA

- tur. incalzire in tub de protectie
- - - - - retur. incalzire in tub de protectie
- radiator tabla de otel echipat cu cap termostatat si ventil de aerisire si de inchidere
- radiator de baie echipat cu cap termostatat si ventil de aerisire si de inchidere
- D-C distribuitor-colector complet echipat (vana de reglare pe retur)
- robinet sferic
- robinet de inchidere si reglaj de debit

Verificator Expert		Semnatura	Nume	Cerinta	REFERAT de verificare/RAPORT de expertiza tehnica
Verificator/ Expert		Semnatura	Nume	Cerinta	REFERAT de verificare/RAPORT de expertiza tehnica
Beneficiar: CENTRUL DE PROIECTARE SI INGINERIE S.R.L. SANTU MARE, str. Corneliu Coposu 257A, nr. ORC 130/140/2009, CUI 402526958 tel/fax 0744.513.514/0361.884.017, e-mail: office@cpim.ro					
Proiect nr. 5613/PI/2016					
Beneficiar: COMUNA GILGAU, JUDEȚUL SALAJ					
Specificatie	Nume	SCARA	Titlu proiect		
Proiectat	ing. MANESES SANDOR	%	MODERNIZARE CAMIN CULTURAL		
Desenat	ing. VARGA ERIKA		IN SATUL DOBROCIINA, COMUNA GILGAU		
Scara					
Titlu planșă:					
Planșă nr.:					
Inșelaj:					
Arh.:					

Nota: Cosul de fum este detaliat in proiectul de Rezistenta

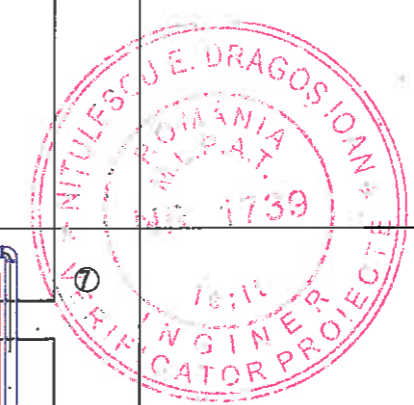
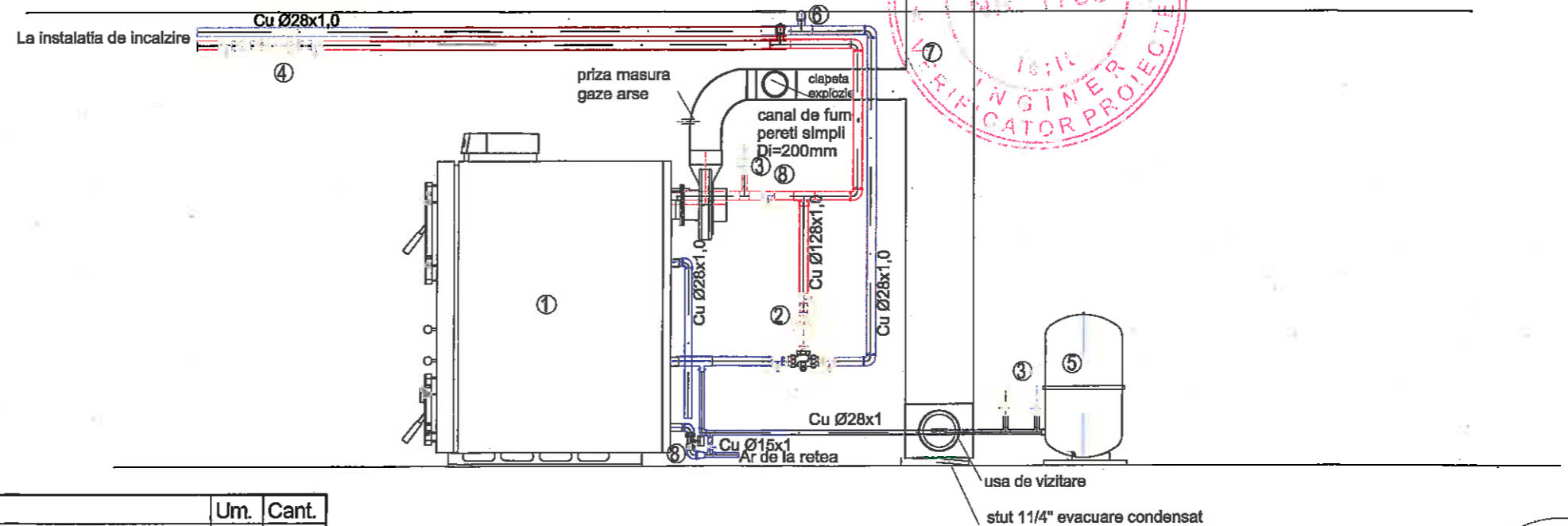
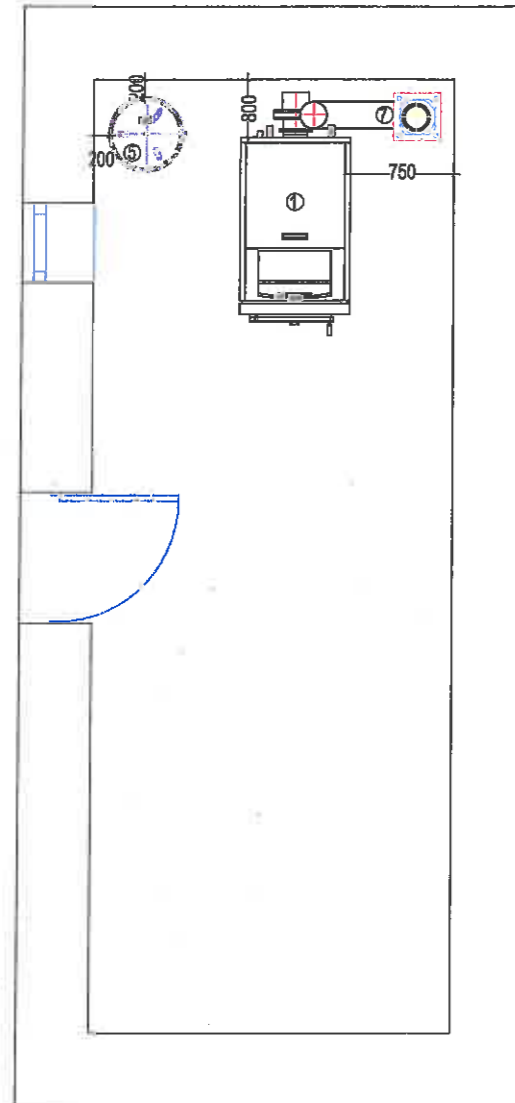

Nr.	Nume	Um.	Cant.
1	Cazan combustibil solid 25 kW	buc	1
2	Dispozitiv ridicare temperatura retur 25 kW	buc	1
3	Supapa de siguranta Dn25	buc	3
4	Pompa circuit incalzire Q=0.2l/s, H=4.03 m	buc	1
5	Vas de expansiune 80 l	buc	1
6	Aerisor automat	buc	2
7	Canal si cos de fum Dn 160, H 8m	buc	1
8	Vana cu 2 cai Dn 25	buc	1

LEGENDA

- Cu Ø28x1 Teava de cupru semidur traseu retur
- Cu Ø28x1 Teava de cupru semidur traseu tur
- Robinet sferic
- Clapeta de sens



Verificator					
Expert					6571/15-07-2016
Verificator/ Expert	Nume	Semnatura	Cerinta	REFERAT de verificare/RAPORT de expertiza tehnica	
CENTRUL DE PROIECTARE SI INGINERIE S.R.L. SATU MARE, str. Corneliu Coposu 2/57A, nr. ORC.130/440/2009, CUI RO25628958 tel/fax 0744.513.524/0361.884.017, e-mail: office@cpism.ro			Beneficiar:		Proiect nr.
			COMUNA GILGAU, JUDETUL SALAJ		56/C30/ PTH/2016
Specificatie	Nume	Semnatura	SCARA 1:50 1:%	Titlu proiect:	
Proiectat	ing. MANESSES SANDOR		data	MODERNIZARE CAMIN CULTURAL IN SATUL DOBROCINA, COMUNA GILGAU	
Desenat	ing. VARGA ERIKA		MAI 2016	Titlu plansa:	
Sef Proiect	arh. NEGRU OVIDIU			Instalatii Termice PLAN SI SCHEMA CENTRALA TERMICA	
				Faza	IT 04
				P.TH.	
				D.D.E.	
				Plansa nr.	

PROFIL TRANSVERSAL CANALIZARE

	Cadru	Zm	By
Cota finis amenajat	-0.2	-0.2	-0.2
Cota radier canal	-1.1	-1.12	-1.21
Panta Conducta	0.01	0.01	0.01
Distanța între cadrane	2	8.00	0.00
Distanța cumulat	2	11.00	11.00
Diametrul conductei	110	160.00	160.00

SECTIUNE BRANSAMENT APA

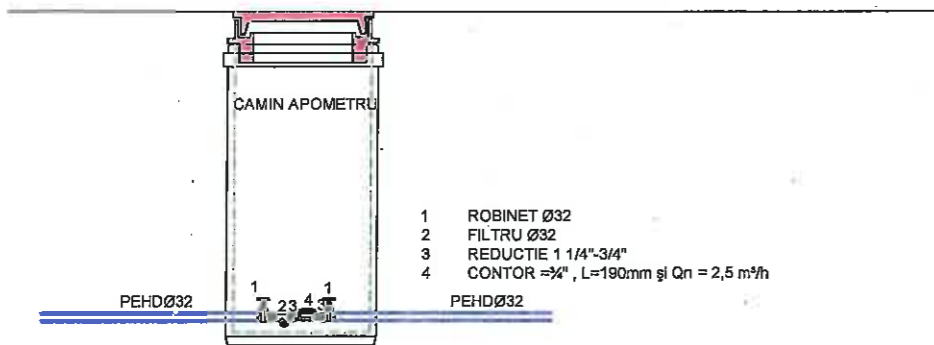

Detaliu camin racord-bazin vidanjabil

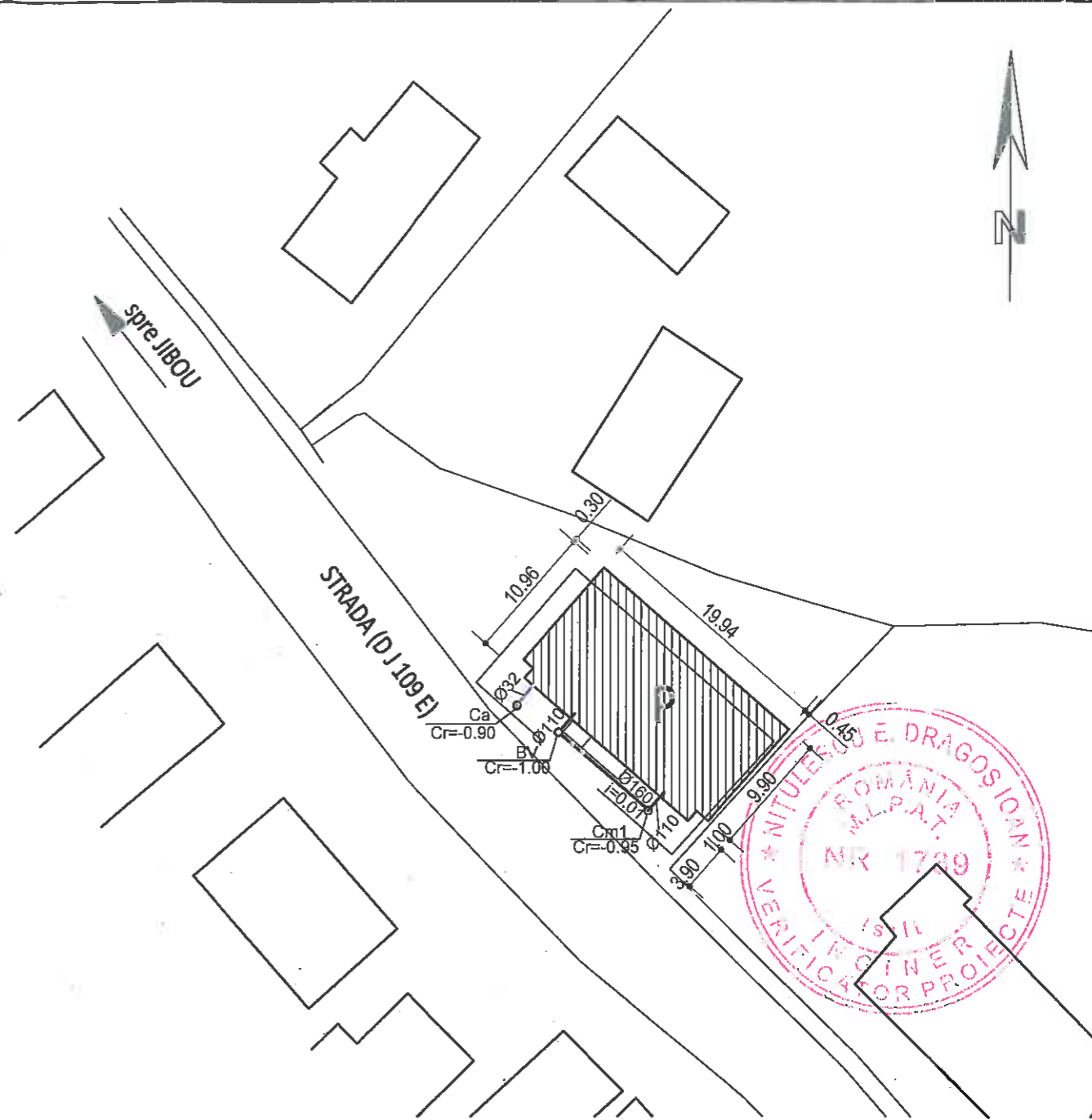
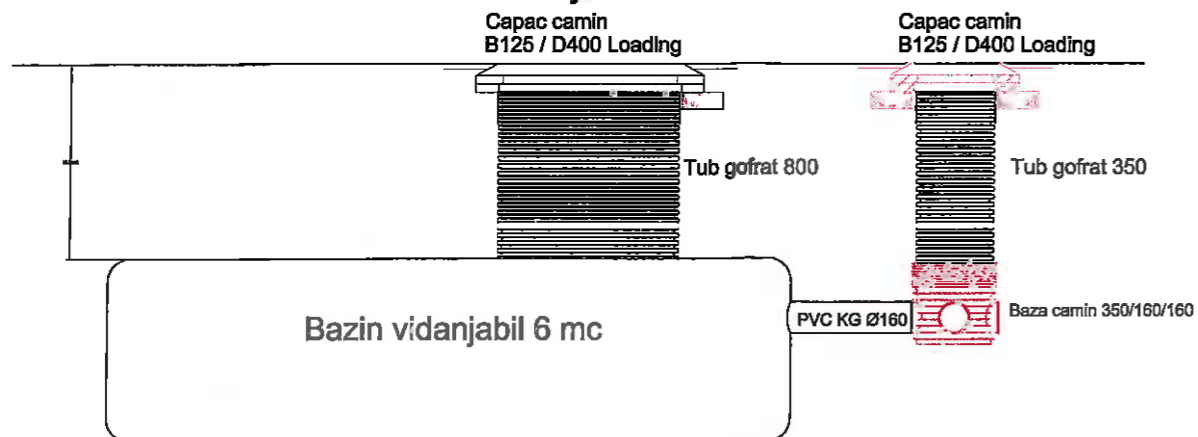

LEGENDA



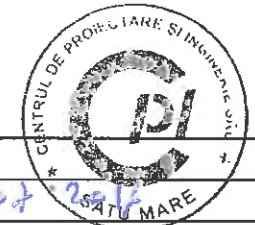
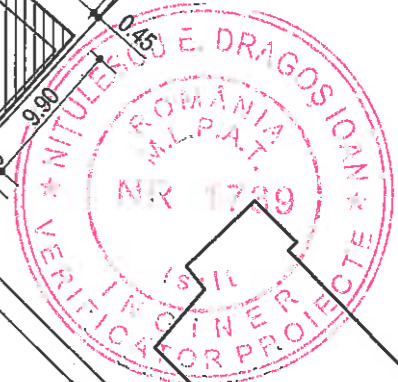

- CONSTRUCTIE PROPUSA PT. MODERNIZARE
- CONDUCTA DE APA PEHD
- CONDUCTA DE CANALIZARE
- Cm** CAMIN CANALIZARE MENAJERA
- BV** BAZIN VIDANJABIL
- Ca** CAMIN APOMETRU

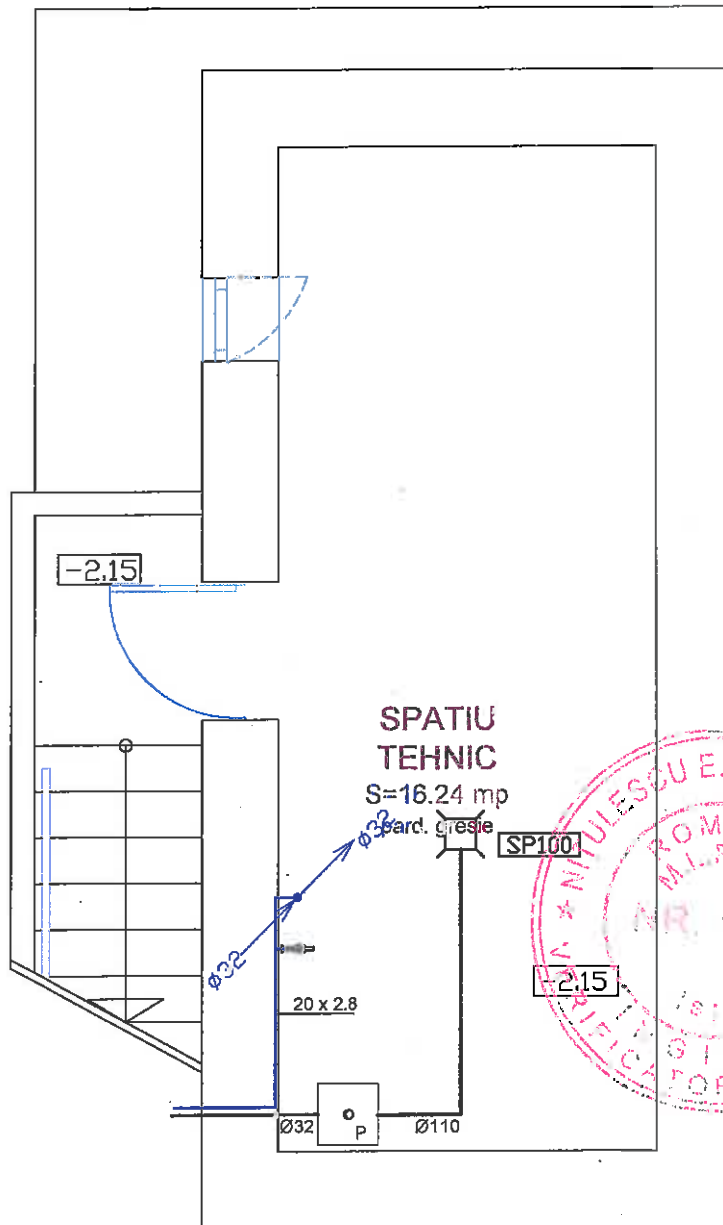

Verificator					
Expert					
Verificator/Expert	Nume	Semnatura	Cerinta	REFERAT de verificare/RAPORT de expertiza tehnica	
CENTRUL DE PROIECTARE SI INGINERIE S.R.L. SATU MARE, str. Corneliu Coposu 2/57A, nr. ORC 130/440/2009, CUI RO25628958 tel/fax 0744.513.524/0361.884.017, e-mail: office@cpism.ro			Beneficiar:		Proiect nr.
			COMUNA GILGAU, JUDETUL SALAJ		56/C30/ PTH/2016
Specificatie	Nume	Semnatura	SCARA	Titlu proiect:	
Proiectat	ing. MANESSES SANDOR		1:500	MODERNIZARE CAMIN CULTURAL IN SATUL DOBROCINA, COMUNA GILGAU	
Desenat	ing. VARGA ERIKA		data	Faza	
Sef Proiect	arh. NEGRU OVIDIU		MAI 2016	P.TH.+D.D.E	
			Titlu planșă:		Planșă nr.
			Instalatii Sanitare PLAN REțele EXTERIOARE, DETALII EXECUTIE		IS 01



LEGENDA

-  Conducta de apa rece
-  Conducta de canalizare menajera PVC KG
-  Robinet sferic
-  Sifon pardoseala
-  P Pompa pentru ape uzate



Verificator				
Expert				
Verificator/ Expert	Nume	Semnatura	Cerinta	REFERAT de verificare/RAPORT de expertiza tehnica
 CENTRUL DE PROIECTARE SI INGINERIE S.R.L. SATU MARE, str. Corneliu Coposu 2/57A, nr. ORC.130/440/2009, CUI RO25628958 tel/fax 0744.513.524/0361.884.017, e-mail: office@cplsm.ro			Beneficiar:	COMUNA GILGAU, JUDETUL SALAJ Proiect nr. 56/C30/ PTH/2016
Specificatie	Nume	Semnatura	SCARA	Titlu proiect: MODERNIZARE CAMIN CULTURAL IN SATUL DOBROCINA, COMUNA GILGAU
Proiectat	ing. MANESSES SANDOR		1:50	
Desenat	ing. VARGA ERIKA		data	Titlu plansa: Instalatii Sanitare PLAN DEFINSOI
Sef Proiect	arh. NEGRU OVIDIU		MAI 2016	
				Faza P.TH.+ D.D.E.
				Plansa nr. IS 02

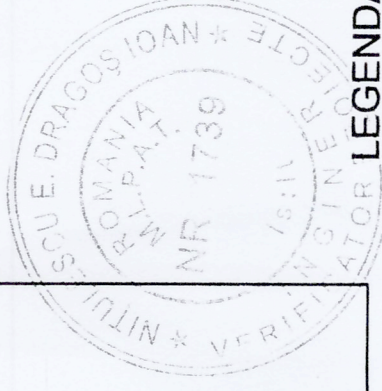
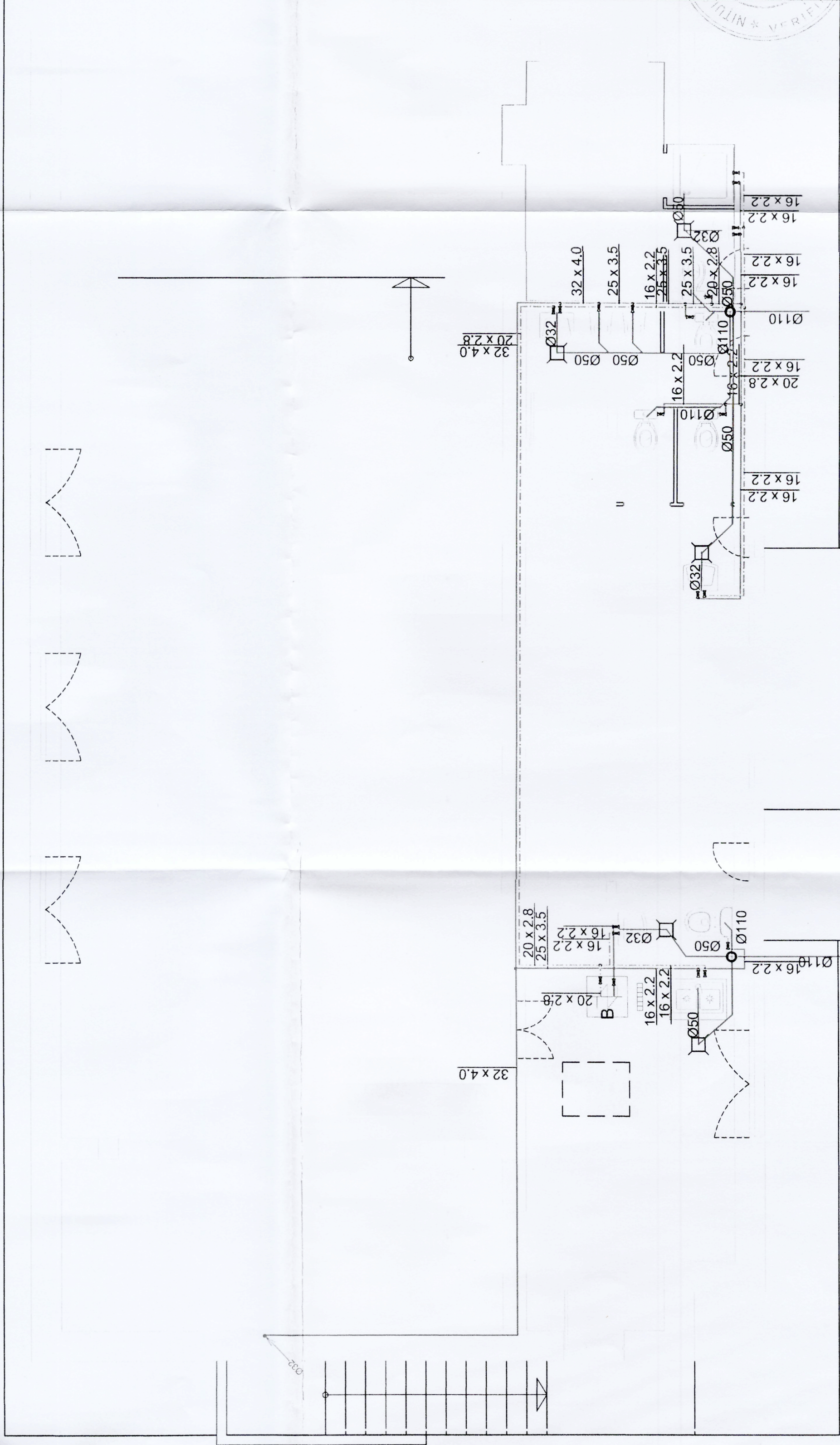

LEGENDA

- Conducta de apa calda
- Conducta de apa rece
- Conducta de canalizare menajera PVC KG
- Supapa de aerisire canalizare
- Robinet sfertic
- Sifon paroseala
- B Boiler electric 80 l



Verificator Expert							
Verificator/ Expert	Semnatura	Cerinta	10	1087/15.07.2016			
Nume				Beneficiar:			
CENTRUL DE PROIECTARE SI INGINERIE S.R.L.				COMUNA GILGAU, JUDETUL SALAJ			
SITU. MARE str. Corneliu Coposcu 12, IATA nr. GRN.130/140/2006, CUI:RO25269363				REFERAT de verificare/RAPORT de expertiza tehnica			
Tel: nr. 0745.53.53.53, 0361.084.017, Email: office@cpn.ro							
Specificatie	Nume	Semnatura	SCARA	Titlu proiect:			
Proiectat	Fig. MANES SANDOR		1:50	MODERNIZARE CAMIN CULTURAL			
Desenat	Fig. VARGA ERIKA		data	IN SATUL DOBROCIJA, COMUNA GILGAU			
Sef Proiect	am. NEGRU OVIDIU		mai 2016	Titlu plansa:			
				INSTANȚA SCRIȘTE PLAN PĂRȚIER			
				Proiect nr. SA/CSP/PH/005			
				Faza P.T.H.+ D.D.E.			
				Plansa nr. 15 03			

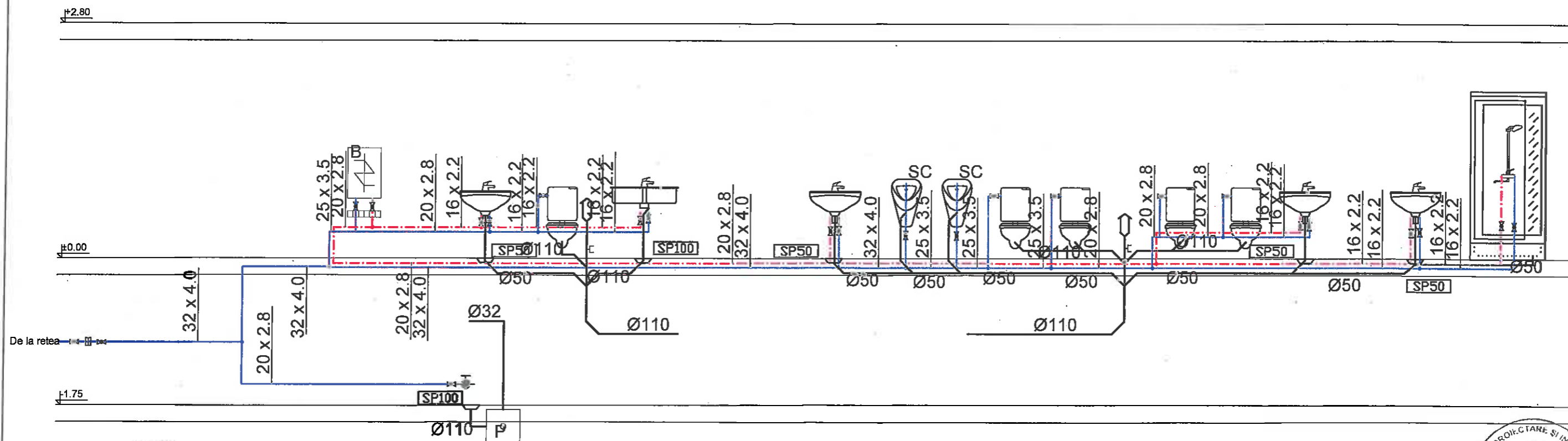

LEGENDA

- - - Conducta de apa calda
- Conducta de apa rece
- Conducta de canalizare menajera PVC KG
- Supapa de aerisire canalizare
- Robinet sferic
- Sifon pardoseala
- Robinet portfurtun
- B** Boiler Electric 80l
- P** Pompa ape uzate



Verificator				
Expert				15 / 15.07.2016
Verificator/ Expert	Nume	Semnatura	Cerinta	REFERAT de verificare/RAPORT de expertiza tehnica
CENTRUL DE PROIECTARE SI INGINERIE S.R.L. SATU MARE, str. Corneliu Coposu 2/57A, nr. ORC 130/440/2009, CUI RO25628958 tel/fax 0744.513.524/0361.884.017, e-mail: office@cpism.ro			Beneficiar:	
			COMUNA GILGAU, JUDETUL SALAJ	
Specificatie	Nume	Semnatura	SCARA	Titlu proiect:
Proiectat	ing. MANESSES SANDOR		%	MODERNIZARE CAMIN CULTURAL IN SATUL DOBROCINA, COMUNA GILGAU
Desenat	ing. VARGA ERIKA		data	
Sef Proiect	arh. NEGRU OVIDIU		MAI 2016	Titlu plansa: Instalatii Sanitare SCHEMA COLOANELOR
				Proiect nr. 56/C30/ PTH/2016
				Faza P.TH.+ D.D.E.
				Plansa nr. IS 04

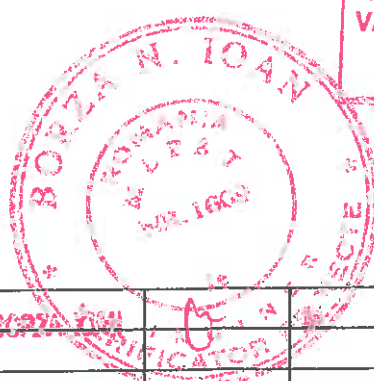
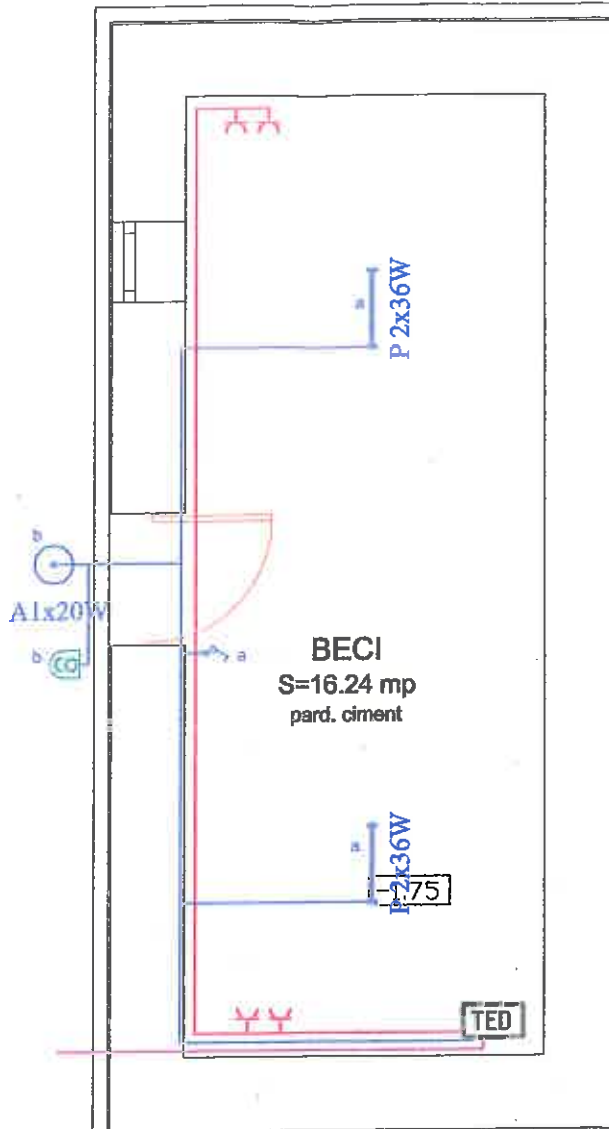

VALID PENTRU FAZA D.T. (D.T.A.C.) LA
 AUTORITATEA DE CONSTRUIRE -
 PARTEA A PROGRAMULUI DIN P.TH. SI D.E.

ing. SANGEORZAN RADU
 aut. ANRE nr. 40131/2016, gr. IIA+63

Verificator	Verificator Prof. dr. ing. BORZA N. IOAN		No 0345 / 20.IUL.2016	
Expert				
	Nume	Semnatura	Cerinta	REFERAT de verificare/RAPORT de expertiza tehnica
 CENTRUL DE PROIECTARE SI INGINERIE S.R.L. SATU MARE, str. Corneliu Coposul 2/57A, nr. ORC.130/440/2009, CUI RO25628958 tel/fax 0744.513.524/0361.884.017, e-mail: office@cpism.ro	Beneficiar:		COMUNA GILGAU, JUDETUL CLUJ	
	Proiect nr. 4/C3/PTW/2016		Faza P.TH.	
Specificatie	Nume	Semnatura	SCARA	Titlu proiect:
Sef Proiect	arh. NEGRU OVIDIU		1:50	MODERNIZARE CAMIN CULTURAL IN SATUL DOBROCINA, COMUNA GILGAU
Proiectat	ing. SANGEORZAN RADU		data	Titlu plansa:
Desenat	ing. SANGEORZAN RADU		2016	PLAN DEMISOL - INSTALATII EL.
				Plansa nr. IE1

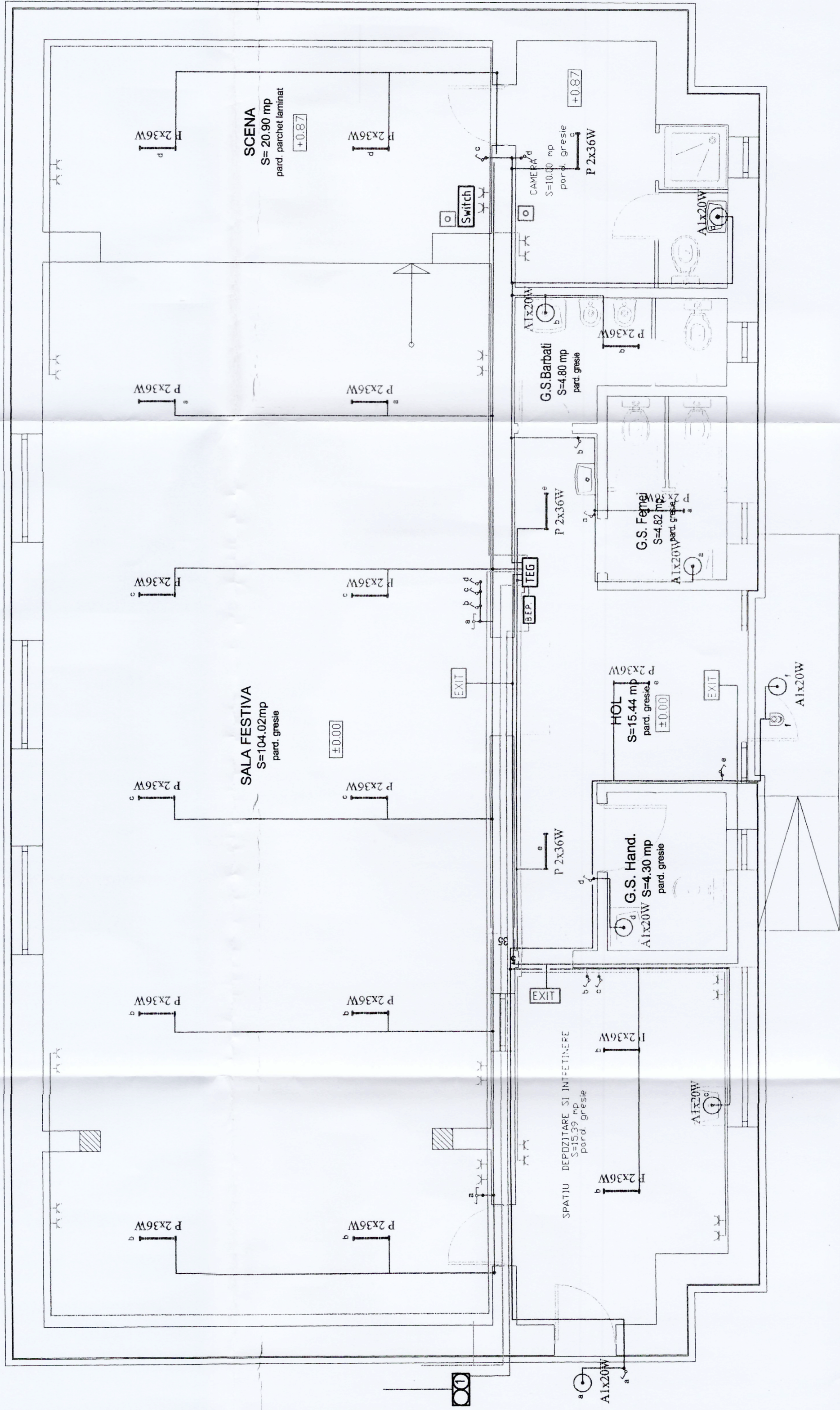

LEGENDA:

- circuit iluminat (3xFY1,5mm)
- circuit prize (3xFY2,5mm)
- circuit iluminat de siguranta (3xFY1,5mm)
- circuit alimentare tablouri
- corp de iluminat cu tub fluorescent
- ⊙ corp de iluminat cu lampa fluorescanta compacta
- ⊙ senzor de miscare cu acoperire de 360 grade
- corp de iluminat in caz de avarie 10W
- priza simpla sau dubla cu contact de protectie
- intrerupator simplu ST
- comutator capat ST
- priza dubla RJ45
- tablou electric general

- priza pamant – platabanda otel zincat 40x4mm
- OIZn30x2mm
- legatura priza de pamant – tablou general – platabanda otel zincat 25x4mm
- tarus de impamantare L= 5 m pentru Nivel de protectie IV al IPT
- ⊗ piesa de separatie simpla sau dubla montata aparent pe perete

- 1 - face legatura intre conducta de protectie si priza de pamant
- 2 - face legatura intre conductorul de coborare al instalatiei de paratrznat si priza de pamant



VALABIL PENTRU FAZA D.T. (D.T.A.C.) LA
AUTORITATEA DE CONSTRUIRE -
VERIFICATOR PROIECTANT: COPAZA ZOLTAN, Th. și D.E.

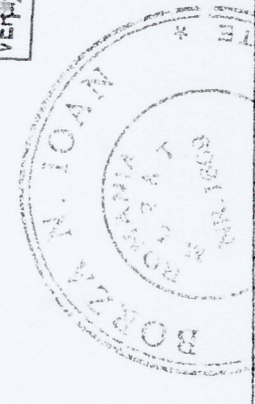

ing. SANGEORZAN RADU
out. ANE nr. 40131/2016, gr. IAHB

Verificator	VERIFICATOR	Proiectant	COPAZA ZOLTAN	No 0345 / 20.IIUL.2016	
Expert		Nume		Semnatura	
		Cerinta			
					REFERAT de verificare/RAPORT de expertiza tehnica

Beneficiar:		COMUNA GILGAU, JUDEȚUL CLUJ	
Proiect nr.	413/PT/2016	Faza	P.T.H.
Titlu proiect:	MODERNIZARE CĂMIN CULTURAL IN SATUL DOBROCINA, COMUNA GILGAU	SCARA	1:50
data	2016	data	2016
Titlu planșă:	PLANȘA DE PROIECTARE	Desenat	ing. SANGEORZAN RADU
		Semnat	ing. SANGEORZAN RADU

CENTRUL DE PROIECTARE SI INGINERIE S.R.L.
SATU MARE, str. Comuna Copaza 257A, nr. 01C.150/40/2005, CUI R02528593
tel/fax 074513.524/051.884.017, e-mail: office@cpim.ro

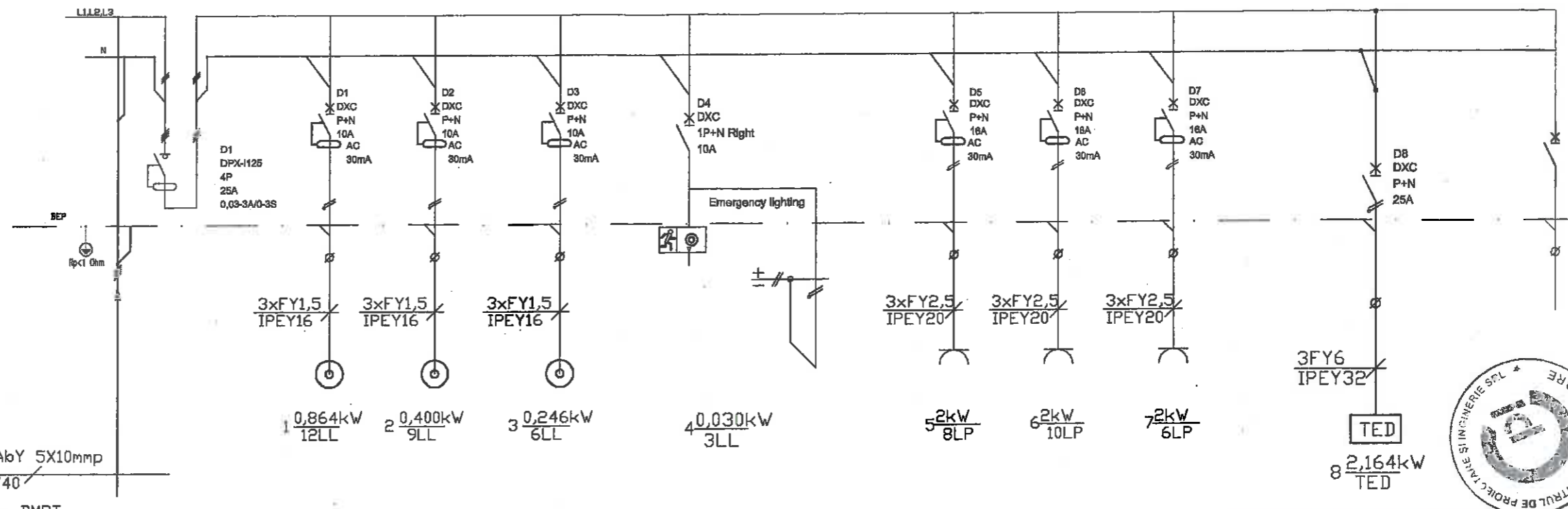

ACYAbY 5X10mmp
IPEY40
de la BMPT



VALABIL PENTRU FAZA D.T. (D.Y.A.G.) LA
- AUTORIZAȚIA DE CONSTRUIRE -
PARTE INTEGRANTĂ DIN P.TH. și D.E.

TEG
PI=9,70 kW
Pa=7,76kW

Alimentare 3P+N+PE ~50Hz 400V	ILUMINAT	PRIZE	CIRCUIT REZERVA

ing. SANGEORZAN RADU
aut. ANRE nr. 40131/2016, gr. IIA+IIB

Verificator	VERIFICATOR Proiecting DOBROZAN			No 3 4 5 / 20.10.2016	
Expert					
	Nume	Semnatura	Cerinta	REFERAT de verificare/RAPORT de expertiza tehnica	
	CENTRUL DE PROIECTARE SI INGINERIE S.R.L. SATU MARE, str. Corneliu Coposu 2/57A, nr. ORC.130/440/2009, CUI RO25628958 tel/fax 0744.513.524/0361.884.017, e-mail: office@cpism.ro			Beneficiar:	
				COMUNA GILGAU, JUDETUL CLUJ	
Specificatie	Nume	Semnatura	SCARA	Titlu proiect:	
Sef Proiect	arh. NEGRU OVIDIU			MODERNIZARE CAMIN CULTURAL IN SATUL DOBROCINA, COMUNA GILGAU	
Proiectat	ing. SANGEORZAN RADU		data	Titlu plansa:	
Desenat	ing. SANGEORZAN RADU		2016	SCHEMA MONOFILARA - TEG	
				Proiect nr. 4/C3/PTH/2016	
				Faza P.TH.	
				Plansa nr. IE3	

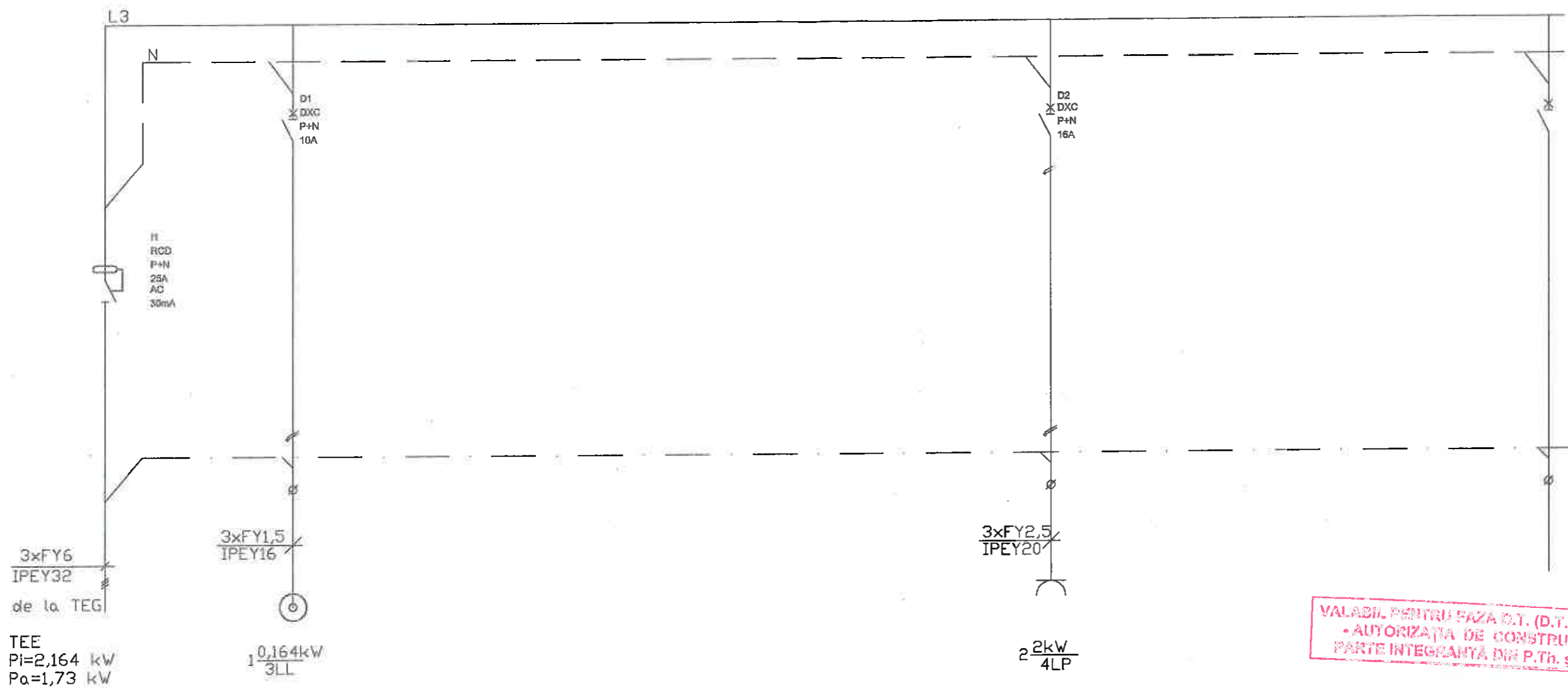

VALABIL PENTRU FAZA D.T. (D.T.A.C.) LA
 -AUTORIZAȚIA DE CONSTRUIRE -
 PARTE INTEGRANTĂ DIN P.Th. și D.E.

Alimentare P+N+PE ~50Hz 240V	ILUMINAT	PRIZE	CIRCUIT REZERVA
---------------------------------------	----------	-------	-----------------



ing. SANGEORZAN RADU
 aut. ANRE nr. 40131/2016, gr. IIA+IIB



Verificator	VERIFICATOR SANGEORZAN RADU		No 0345 / 20.IUL.2016	
Expert				
	Nume	Semnatura	Cerinta	REFERAT de verificare/RAPORT de expertiza tehnica
CENTRUL DE PROIECTARE SI INGINERIE S.R.L. SATU MARE, str. Corneliu Coposul 2/57A, nr. ORC J30/440/2009, CUI RO25628958 tel/fax 0744.513.524/0361.884.017, e-mail: office@cpism.ro	Beneficiar:		COMUNA GILGAU, JUDETUL CLUJ	
	Proiect nr. 4/C3/PTH/2016			
Specificatie	Nume	Semnatura	SCARA	Titlu proiect: MODERNIZARE CAMIN CULTURAL IN SATUL DOBROCINA, COMUNA GILGAU
Sef Proiect	arh. NEGRU OVIDIU	[Signature]		Faza P.TH.
Proiectat	ing. SANGEORZAN RADU		data	Titlu plansa: SCHEMA MONOFILARA - TED
Desenat	ing. SANGEORZAN RADU		2016	Plansa nr. IE4